

FN 75

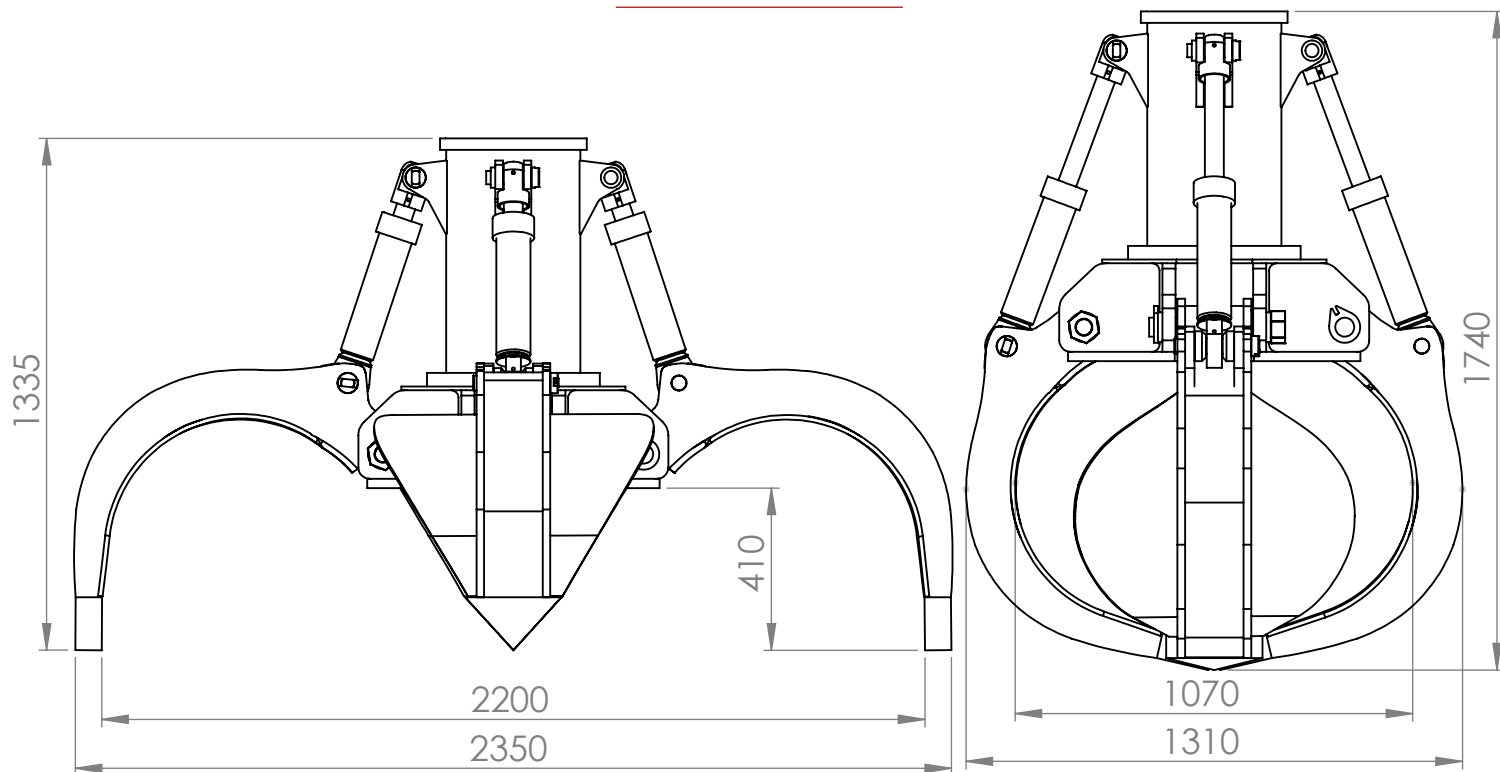

CAPACIDAD/ CAPACITY	PRESIÓN DE TRABAJO/WORKING PRESSURE	NÚMERO DE PALAS/NUMBER OF CLAWS	PESO/ WEIGHT (KG)	FUERZA DE CIERRE/TIGHTENING FORCE
500 L	350 BAR	4/5	1183/4 1355/5	1800 KG

**SE PUEDEN ADAPTAR LOS SIGUIENTES GIROS:
 CAN ADAPT THE FOLLOWING TURNS:**

IR 20

